

**USER'S
MANUAL**

FA140C Security System

N7229-1 7/94

**First
Alert**
PROFESSIONAL
SECURITY SYSTEMS

TABLE OF CONTENTS

SYSTEM OVERVIEW	3	ARMING PERIMETER ONLY (INSTANT)	17
General.....	3	ARMING ALL PROTECTION (AWAY)	18
Keypads.....	3	ARMING ALL PROTECTION (MAXIMUM)	19
Zones.....	3	DISARMING, AND SILENCING ALARMS	20
Burglary Protection.....	4	EXIT ALARMS	21
Fire Protection.....	4	CHIME MODE	21
Alarms.....	4	PANIC KEYS	22
Memory of Alarm.....	4	OUTPUT RELAY OPTIONS	23
Phone Access & Voice Response Capability.....	4	TESTING THE SYSTEM	24
ABOUT THE KEYPADS	5	TROUBLE CONDITIONS	26
General.....	5	"CHECK" and "BATTERY" Displays.....	26
Keypad Displays.....	5	Power Failure.....	26
Fixed-Word Keypad Displays.....	6	Other Displays.....	27
FUNCTIONS OF THE KEYPAD	8	FIRE ALARM SYSTEM (IF INSTALLED)	29
SECURITY CODES	10	General.....	29
General.....	10	In Case of Fire Alarm.....	29
Duress Code.....	10	Silencing Fire Alarms.....	30
Quick Arming.....	10	NFPA RECOMMENDATIONS	31
To Assign, Change, or Delete User Codes.....	11	EMERGENCY EVACUATION	32
Voice Module.....	11	QUICK GUIDE TO SYSTEM FUNCTIONS	33
ENTRY/EXIT DELAYS	12	SUMMARY OF AUDIBLE/VISUAL NOTIFICATION	34
General.....	12	PROTECTION ZONES LIST	36
Audible Exit Delay Sound.....	12	INSURANCE CREDIT REQUEST FORM	37
CHECKING FOR OPEN ZONES	13	CANADIAN (DOC) STATEMENT	39
BYPASSING ZONES	14	FCC STATEMENTS	40
Using the [BYPASS] Key.....	14	LIMITATIONS STATEMENT	42
Quick Bypass.....	15	SERVICING INFORMATION	43
ARMING PERIMETER ONLY (STAY)	16	WARRANTY	Back Cover

This manual is a step-by-step guide that will acquaint you with the system's features and benefits. It defines the components and their functions, describes their operation, and instructs you with normal and emergency procedures.

Keep this manual in a convenient place so that you can refer to it as necessary.

SYSTEM OVERVIEW

General Congratulations on your ownership of a First Alert Professional Security System. You've made a wise decision in choosing it, for it represents the latest in security protection technology today, including microcomputer technology to monitor all system status.

Basically, this system offers you three forms of protection: burglary, fire and emergency. Your system may consist of at least one keypad which provides full control of system operation, various sensors such as motion detectors and door and window sensing devices, plus a selected number of strategically placed smoke or combustion detectors designed to provide early warning in case of fire. Your system may also have been programmed to automatically transmit alarm or status messages over the phone lines to a central alarm monitoring station.

All system functions are controlled by your keypad(s), which are described in the next section, *ABOUT THE KEYPADS*.

Zones Your system's sensing devices have been assigned to various "zones". For example, the sensing device on your Entry/Exit door may have been assigned to zone 06, sensing devices on windows in the master bedroom to zone 10, and so on. These zone numbers will appear on the display when an alarm or trouble condition occurs.

Burglary Protection The burglary protection portion of your system must be turned on or "armed" before it will sense burglary alarm conditions and sound an alarm. Your system can be armed in one of four modes: STAY, AWAY, INSTANT and MAXIMUM. Refer to the *ARMING THE SYSTEM* sections for instructions in using these modes of operation.

Your system also provides a CHIME mode for alerting you to the opening and closing of doors and windows while the system is disarmed.

SYSTEM OVERVIEW

Fire Protection The fire protection portion of your security system (if used) is always on and will sound an alarm if a fire condition is detected. Refer to the *FIRE ALARM SYSTEM* section for important information concerning fire protection, smoke detectors and planning emergency exit routes from your house.

Alarms When an alarm occurs, both the keypad and external sounders will sound, and a message at the keypad will identify the zone(s) causing the alarm. In addition, if your system is connected to a central monitoring station, an alarm message will be sent. To stop the alarm sounding, you simply disarm the system.

Memory Of Alarm When an alarm or trouble condition occurs, the keypad displays the number(s) of the zone(s) that caused the problem, and displays the type of alarm or trouble (ex. FIRE, ALARM, CHECK). The display remains until it is cleared by entering the OFF sequence (security code + **OFF** key) twice.

Phone Access & Voice Response Capability If your system includes a voice module it will permit you to access the system via a Touch-tone phone, either on-premises or by call-in when away. The phone access feature will enable you to determine the status of the system and perform most system commands (including arming and disarming) over the phone.

ABOUT THE KEYPADS

General Your keypad(s) (see page 7) allow you to control all system functions. The keypads feature a telephone style (digital) keypad and a Liquid Crystal Display (LCD) which shows the nature and location of all occurrences.

The keypads feature a built-in sounder which emits alarm sounds during alarm conditions and produces warning tones during entry (and exit, if so programmed) delay periods. The sounder also provides acknowledgement tones when keys are pressed, and confirmation tones for successful command entries.

The keys are located behind a flip-down cover which can be removed, if desired.

Keypad Displays There are two basic types of keypad displays, Alpha and Fixed-Word, either of which may have been used in your system.

- **Alpha Keypad Displays** feature a 2-line, 32 character alphanumeric Liquid Crystal Display (LCD) which can display the nature and location of all occurrences in friendly English.
- **Fixed-Word Keypad Displays** are functionally similar to the Alpha Keypads, except that their LCD display uses pre-designated (fixed) words to identify the nature and location of occurrences. Words displayed on all Fixed-Word keypads are the same, except that their location in the display window will vary with various models (see the next page).

Unless stated otherwise, all commands and procedures described herein apply equally to all keypads.

ABOUT THE KEYPADS

Fixed-Word Keypad Displays

AWAY	All burglary zones, interior & perimeter, are armed.
STAY	Perimeter burglary zones, such as windows and doors are armed.
INSTANT	Perimeter burglary zones armed and entry delay is turned off.
BYPASS	One or more burglary protection zones have been bypassed.
NOT READY	Appears when burglary portion of the system is not ready for arming (due to one or more open protection zones).
READY	The burglary portion of the system is ready to be armed.
NO AC	Appears when AC power has been cut off. System is operating on backup battery power.
AC	Appears when AC power is present.
CHIME	Appears when the CHIME feature is ON.
BAT	<i>Low system battery</i> if no zone number is shown, or <i>Low battery condition in a wireless sensor</i> if zone number is <i>also</i> shown.
ALARM	Appears when an intrusion has been detected and the system is armed (also appears during a Fire alarm). Accompanied by the ID # of the zone in alarm.
CHECK	Appears when a malfunction is discovered in the system at any time or if a fault is detected in a FIRE zone at any time or in a DAY(Trouble)/NIGHT(Alarm) burglary zone during a disarmed period. Accompanied by a display of zone number in trouble.
FIRE	Appears when a fire alarm is present. Accompanied by a display of the zone # in alarm.

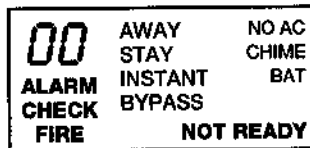

TYPICAL
FIXED-WORD DISPLAYS

ABOUT THE KEYPADS

TYPICAL KEYPADS
(SHOWN WITH KEYPAD COVER REMOVED)

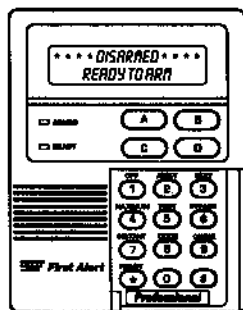

FA550KP ALPHA KEYPAD

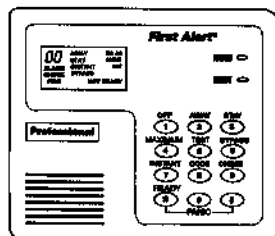

FA210KP

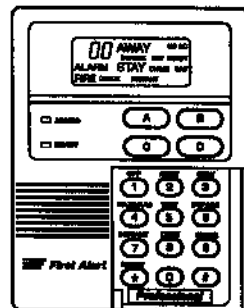

FA250KP

FIXED-WORD KEYPADS

FUNCTIONS OF THE KEYPAD

SEE TYPICAL KEYPAD ON NEXT PAGE

- DISPLAY WINDOW:** Displays protection zone ID and system status messages.
- 1 OFF KEY:** Disarms burglary portion of the system, silences alarms and audible trouble indicators, and clears visual display after problem's correction.
- 2 AWAY KEY:** Arms the entire burglary system, perimeter and interior.
- 3 STAY KEY:** Arms perimeter portion of burglary system only. Interior protection is not armed, which allows movement within premises without causing alarm.
- 4 MAXIMUM KEY:** Arms in manner similar to AWAY mode, but without the entry delay feature, thus providing maximum protection. An alarm will occur immediately upon opening any protection point, including the main door.
- 5 TEST KEY:** Tests the system and alarm sounder if disarmed. Refer to *TESTING THE SYSTEM* section for test procedures.
- 6 BYPASS KEY:** Removes individual protection zones from being monitored by the system.
- 7 INSTANT KEY:** Arms in manner similar to STAY mode, but without the entry delay feature. Entering via the entry/exit door will cause an instant alarm.
- 8 CODE KEY:** Used to assign additional user codes for other users of the system.
- 9 CHIME KEY:** Turns CHIME mode on and off. When on, the opening of windows or doors while the system is disarmed will sound 3 beeps at the keypad(s).
- * READY KEY:** Displays all open protection zones.
- # KEY:** "Quick Arm" key permits ARMING of the system without use of a security code (if so programmed).
- KEYS 0-9†:** Used to enter your security code(s).
- READY INDICATOR: (GREEN)** Lit when the system is ready to be armed (no faults present). While the system is disarmed, this indicator will go on and off as protection zones are closed and opened.
Note: On some keypads there is, instead, a **POWER INDICATOR (GREEN)** which is lit when AC power is present. If the indicator is off, the system may still be operating, but on its backup battery power. See *Power Failure* in *TROUBLE CONDITIONS* section.
- ARMED INDICATOR: (RED)** Lit when the system has been armed (STAY, AWAY, INSTANT or MAXIMUM).
- INTERNAL SOUNDER:** The built-in keypad sounder mimics the alarm sounder during alarms, and will also "beep" during certain system functions (see *SUMMARY OF AUDIBLE/ VISUAL NOTIFICATION*).
- EMERGENCY (PANIC) KEYS:** Individual keys **A, B, and C** (key **D** not used). On some keypads, these keys are not present and other keys may be available for emergency functions. For further information, refer to the *PANIC KEYS* section.

†**Note:** Keys **1** through **9** each perform their associated companion functions (OFF, AWAY, STAY, etc.) when preceded by an entry of the security code (as described later).

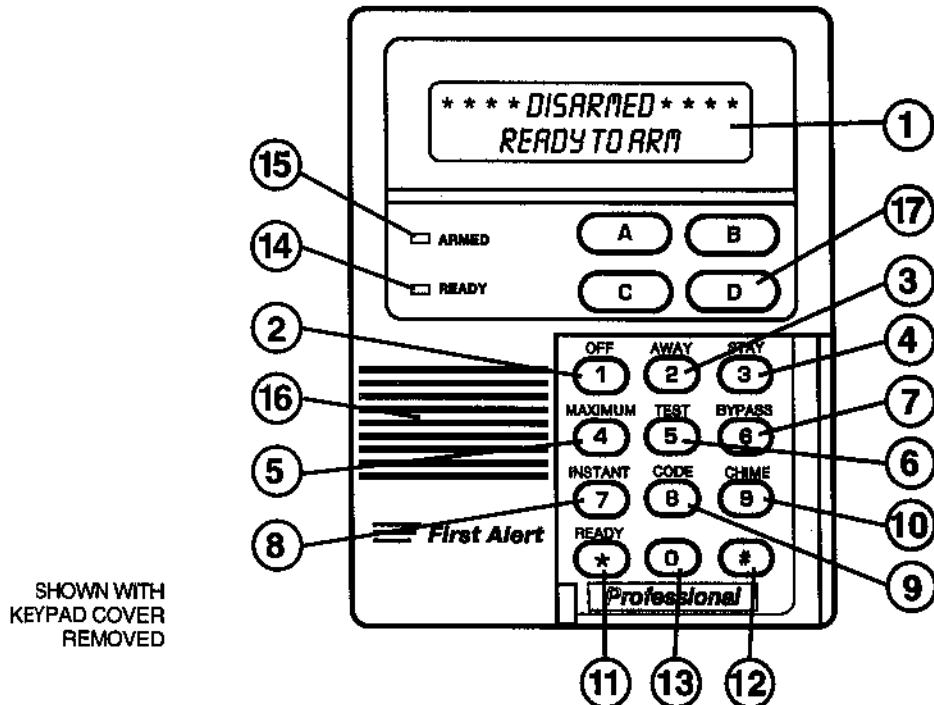

SHOWN WITH
KEYPAD COVER
REMOVED

TYPICAL ALPHA KEYPAD

Fixed-Word Keypads are functionally similar, except for screen displays.

IMPORTANT! When entering codes and commands, sequential key depressions must be made within 2 seconds of one another. If 2 seconds elapses without a key depression, the entry is aborted and must be repeated from its beginning.

SECURITY CODES

General At the time of installation, your installer programmed a personal four-digit Master code, known only to you and yours. This code is used to perform most system functions, including arming and disarming of the system. As an additional safety feature, temporary user codes can be assigned (see next page) for use by those not having a need to know the Master code. Note that the Master code remains in effect even when other user codes are assigned.

Duress Code

Ask your installer if the Duress Code feature is active for your system, and if so, check here:

This feature is intended for use when you are forced to disarm or arm the system under threat. When used, the system will act normally, but can silently notify the central station of your situation, if that service has been provided.

The Duress code is the same as your user code, except that the last digit is increased by one.

For example: If the normal security code is "1 2 3 4", the Duress security code is "1 2 3 5".

Important:

- This code is useful only when connected to a central station.
- User codes that end in "9" (ex. 6349) cannot activate a duress alarm (i.e., 6350 is not a duress alarm code).

Quick Arming

Ask your installer if "Quick Arming" is active for your system, and if so, check here:

If your system supports "Quick Arming", the "#" key can be pressed in place of the security code when arming the system. The security code is *a/ways* required, however, when disarming the system.

SECURITY CODES

To Assign, Change, or Delete User Codes

USER NUMBERS

User Numbers available for your system are:

2, 3, 4, 5, 6, and 7

4-DIGIT USER CODES

It is recommended that obvious codes such as 1111 or 1234 not be assigned.

Voice Module

Ask your installer if your system includes a voice module, and if so, obtain your 2-digit phone code and check here:

1. Enter your Master code and press the **CODE** key.
2. Enter single-digit User Number (see box at left) for whom a code is to be assigned, changed, or deleted.
3. **If assigning or changing a user's code**, enter the desired 4-digit code for use by that User Number. The keypad will beep once.
If deleting a user's code, perform steps 1 and 2 and then stop. In a few moments the keypad will beep once, indicating that the existing code has been deleted.

Important:

- Instruct other users to enter their codes carefully to avoid accidentally entering the Duress code. If desired, other users can be assigned a code ending in "9", to prevent accidental Duress code entry.
- Temporary users should not be shown how to use any system function they do not need to know (e.g., bypassing protection zones).
- Be sure user codes do not conflict with any Duress code.

If your system includes a voice module it will permit you to access the system via a Touch-tone phone, either on-premises or by call-in when away. You can:

- Receive voice messages over the phone regarding system status.
- Arm and disarm the system and perform most function commands.

Complete information regarding the use of this feature is provided in a separate manual: **Phone Access User's Guide** that accompanies the voice module.

- Notes:**
- To turn off an alarm (with any system), enter: Security Code + [1/OFF] key.
 - The "CALL-IN TAMPER" ("CI") keypad display and logic described in the guide is not present in your system.
 - The Relay Command Mode described in the guide is not active with your system, but output relay actions may still be controlled if installer-programmed.

ENTRY/EXIT DELAYS

General Information

Your system has preset time delays, known as exit delay and entry delay. When you arm your system, **exit delay** gives you time to leave through the entry/exit door without setting off an alarm. **Entry delay** gives you time to disarm the system when you reenter through the entry/exit door. The system must be disarmed, however, before the entry delay period ends, or an alarm will occur. The keypad will beep slowly during the entry delay period, reminding you to disarm the system.

You can also arm the system with no entry delay at all by using either INSTANT or MAXIMUM arming modes. These modes can provide greater security while you are sleeping or while you are away for extended periods of time.

Exit Delay Alerting Sound

If so programmed by your installer, when arming AWAY (see page 18) or MAXIMUM (see page 19), slow beeps will sound from the keypad during exit delay, turning to fast beeps during the final five seconds of the delay time.

Ask your installer if this is active for your system, and if so, check here:

See your installer for your delay times and record them here:

Exit Delay: seconds

Entry Delay: seconds

CHECKING FOR OPEN ZONES

***** **Using the READY Key**

Before arming your system, all protected doors, windows and other protection zones must be closed or bypassed (see *BYPASSING PROTECTION ZONES* section), otherwise the keypad will display a "Not Ready" message, and if your keypad has a READY indicator light, it will not be lit. The **READY (*)** key can be used to display all faulted zones, making it easier for you to secure any open zone.

To display faulted zones, simply press and release the **READY (*)** key (do not enter code first). Secure or bypass the zones displayed before arming the system.

A "Ready" message will be displayed when all protection zones have been either closed or bypassed and the keypad's READY indicator light (if present) will be lit.

TO DISPLAY OPEN ZONES,
PRESS THE READY KEY.

TYPICAL DISPLAYS
WHEN NOT READY TO ARM

*DISARMED - PRESS *
TO SHOW FAULTS*

ALPHA

AC
NOT READY

FIXED-WORD

TYPICAL DISPLAYS
INDICATING OPEN PROTECTION ZONE
(AFTER PRESSING READY KEY)

*FAULT 06 FRONT
UPSTAIRS BEDROOM*

ALPHA

06 AC
NOT READY

FIXED-WORD

TYPICAL DISPLAYS
INDICATING "READY TO ARM"

******DISARMED*****
READY TO ARM*

ALPHA

AC
READY

FIXED-WORD

BYPASSING PROTECTION ZONES

Using the

6 BYPASS Key

LIMITATION

The system will not allow fire zones to be bypassed.

All bypasses are removed when an OFF sequence (security code plus OFF) is performed.

This key is used when you want to arm your system with one or more zones intentionally unprotected. The system must be disarmed first.

1. Enter your security code and press the **BYPASS** key.
2. Enter zone number(s) for the zone(s) to be bypassed (e.g., 06, 10, 13, etc.). *Single digit zone numbers must be preceded by a zero (e.g. 05, 06).*
3. When finished, the keypad will momentarily display a "Bypass" message for each bypassed zone number. Wait for these zones to be displayed, to confirm their bypass.
4. Arm the system as usual.

Bypassed zones are unprotected and will not cause an alarm if violated while your system is armed.

TO BYPASS ZONES:

- ENTER CODE.
- PRESS **BYPASS** KEY.
- ENTER ZONE Nos.
- WAIT FOR BYPASSED ZONES TO BE DISPLAYED.
- ARM SYSTEM AS USUAL.

TYPICAL MOMENTARY DISPLAYS OF BYPASSED ZONE

*BYPASS 06 FRONT
UPSTAIRS BEDROOM*

ALPHA

06

BYPASS

AC

FIXED-WORD

BYPASSING PROTECTION ZONES

Quick Bypass

Ask your installer if "Quick Bypass" is active for your system, and determine which box(es) you should check here. →

If your system supports "Quick Bypass", it allows you to easily bypass zones as checked below, without having to enter zone numbers individually. This feature is useful if, for example, you routinely leave certain windows open when arming at night.

Bypass all open (faulted) zones

Bypass *all* open (faulted) zones *plus* these zones, as checked:

17, 30, 31, 46, 47

Not active for your system.

To use this feature, enter your security code, press the **BYPASS** key, then stop. In a few moments, all open zones (and others, if checked above) will be sequentially displayed along with a "Bypass" message. Wait for all bypassed zones to be displayed, then arm the system as usual.

TYPICAL DISPLAYS "READY TO ARM WITH ZONES BYPASSED"

SYSTEM CAN NOW BE ARMED
WITH ZONE(S) BYPASSED.

DISARMED BYPASS
READY TO ARM

ALPHA

AC
BYPASS READY

FIXED-WORD

ARMING PERIMETER ONLY

WITH ENTRY DELAY ON

Using the 3 STAY Key

BEFORE ARMING,
close all doors and windows
(see *CHECKING FOR OPEN
ZONES* on page 13)

Use this key when you are staying inside, but expect someone to use an entry/exit door later.

1. Enter your security code and press the **STAY** key.
2. The keypad beeps three times and displays the armed message. The red **ARMED** indicator lights.
3. The system arms. An alarm sounds immediately if a protected perimeter window or non-entry/exit door is then opened, but you may otherwise move freely throughout the premises.

Later arrivals can enter through an entry/exit door without causing an alarm, but they must disarm the system within the entry delay period to avoid sounding an alarm.

THE **STAY** KEY
ARMS THE PERIMETER,
BUT ALLOWS USE OF
THE ENTRY/EXIT DOOR.

TYPICAL DISPLAYS
"ARMED STAY"

ARMED ***STAY***

ALPHA

STAY AC

FIXED-WORD

ARMING PERIMETER ONLY

WITH ENTRY DELAY OFF

Using the **7** INSTANT Key

BEFORE ARMING,
close all doors and windows
(see *CHECKING FOR OPEN
ZONES* on page 13)

Use this key when you are staying inside and do not expect anyone to use an entry/exit door.

1. Enter your security code and press the **INSTANT** key.
2. The keypad beeps three times and displays the armed message. The red **ARMED** indicator lights.
3. The system arms. An alarm sounds immediately if any protected perimeter door or window is opened, but you may otherwise move freely throughout the premises.

An alarm sounds immediately if anyone opens an entry/exit door.

THE INSTANT KEY
ARMS THE PERIMETER
(INCLUDING THE ENTRY/EXIT DOOR),
WITH NO ENTRY DELAY.

TYPICAL DISPLAYS
"ARMED INSTANT"

*ARMED *INSTANT**

ALPHA

AC
STAY
INSTANT

FIXED-WORD

ARMING ALL PROTECTION

WITH ENTRY DELAY ON

Using the

2 AWAY Key

BEFORE ARMING,
close all doors and windows
(see *CHECKING FOR OPEN
ZONES* on page 13)

Use this key when no one will be staying inside.

1. Enter your security code and press the **AWAY** key.
2. The console beeps twice and displays the armed message. The red ARMED indicator lights.
3. You may leave through an entry/exit door during the exit delay period without causing an alarm.

After exit delay, the system arms and sounds an alarm immediately if a protected window or non-entry/exit door is then opened, or if any movement is detected inside your premises.

You may reenter through an entry/exit door, but must disarm the system within the entry delay period to avoid an alarm.

THE AWAY KEY
ARMS THE ENTIRE SYSTEM
(INTERIOR AND PERIMETER),
BUT ALLOWS USE OF
THE ENTRY/EXIT DOOR.

TYPICAL DISPLAYS
"ARMED AWAY"

*ARMED ***AWAY***
YOU MAY EXIT NOW*

"YOU MAY EXIT NOW" disappears
when exit delay expires.

ALPHA

AWAY

AC

FIXED-WORD

ARMING ALL PROTECTION

WITH ENTRY DELAY OFF

Using the 4 MAXIMUM Key

BEFORE ARMING,
close all doors and windows
(see *CHECKING FOR OPEN
ZONES* on page 13)

Use this key when the premises will be vacant for extended periods of time such as vacations, etc., or when retiring for the night and no one will be moving through protected interior areas.

1. Enter your security code and press the **MAXIMUM** key.
2. The keypad beeps twice and displays the armed message. The red ARMED indicator lights.
3. You may leave through an entry/exit door during the exit delay period without causing an alarm.

After exit delay, the system arms and sounds an alarm immediately if any protected door or window is opened, or if any movement is detected inside your premises.

An alarm sounds immediately, when someone reenters.

**THE MAXIMUM KEY
ARMS THE ENTIRE SYSTEM
(INCLUDING THE ENTRY/EXIT DOOR
WITH NO ENTRY DELAY).**

**TYPICAL DISPLAYS
"ARMED MAXIMUM"**

*ARMED *MAXIMUM**
YOU MAY EXIT NOW

"YOU MAY EXIT NOW" disappears
when exit delay expires.

ALPHA

AWAY AC

INSTANT

FIXED-WORD

DISARMING THE SYSTEM AND SILENCING ALARMS

Using the

1 OFF Key

IMPORTANT:

If you return and the main burglary sounder is on, DO NOT ENTER, but CONTACT THE POLICE from a nearby safe location.

If you return after an alarm has occurred and the main sounder has shut itself off, the keypad will beep rapidly upon your entering, indicating that an alarm has occurred during your absence.

LEAVE IMMEDIATELY, and CONTACT THE POLICE from a nearby safe location.

The **OFF** key is used to disarm the system and to silence alarm and trouble sounds.

To Disarm the System

Enter your security code and press the OFF key. The "Ready" message will be displayed, and the keypad will emit a single tone to confirm that the system is disarmed.

To Silence a Burglary Alarm

SEE IMPORTANT NOTE AT LEFT!

Enter your security code and press the OFF key to silence the alarm (or warning tones of a Memory of Alarm). Note the zone in alarm on the keypad display, and make that zone intact (close door, window, etc.). Now enter the security code plus OFF sequence again to clear the keypad's Memory of Alarm display. If the display will not clear and does not provide a "Ready" message, notify the alarm agency.

To Silence a Fire Alarm simply press the OFF key (the security code is not needed to silence FIRE alarms). To then clear the keypad's Memory of Alarm display, enter your security code and press the **OFF** key.

See page 29 for additional fire alarm information.

See the SUMMARY OF AUDIBLE/VISUAL NOTIFICATION section for information which will help you to distinguish between FIRE (Interrupted/Pulsed) and BURGLARY (Continuous/Steady) alarm sounds.

EXIT ALARMS

Exit Alarm Warning Displays and Sounds

Ask your installer if "Exit Alarm Warning" is active for your system, and if so, check here:

Your system may support and have been programmed for this feature.

When arming, if an exit or interior zone contains a fault during closing *at the time the exit delay ends*, the alarm sounder and keypad sound continuously to alert you that an unwanted alarm can be prevented if you take action:

- *If you disarm the system during the entry delay period that will immediately follow*, the sound stops. The keypad displays "CANCELLED ALARM" or "CA" as well as a zone indication. No message is transmitted to the central station.
- *If the system is NOT disarmed during the immediately following entry delay period*, the sounds continue until the system is disarmed (or alarm sounder timeout occurs). The keypad displays "EXIT ALARM" or "EA" as well as a zone indication. An "exit alarm" message will be sent to the central station.

Note: The latter "EXIT ALARM" conditions also result if an alarm from an exit or interior zone occurs within two minutes after the end of an exit delay.

In any of the above cases, a second OFF sequence (security code + **OFF** key) will clear the keypad display.

CHIME MODE

Using the 9 CHIME Key

This feature can be used only while the burglary system is disarmed.

Your system can be set to alert you to the opening of a door or window while it is disarmed by using CHIME mode. When activated, three tones will sound at the Keypad whenever a door or window is opened. Pressing the **READY** key will display the open protection points.

To turn Chime Mode on, enter the security code and press the **CHIME** key. The CHIME message will appear.

To turn Chime Mode off, enter the security code and press the **CHIME** key again. The CHIME message will disappear.

PANIC KEYS

Using Panic Keys (for manually activating silent and/or audible alarms)

TO INITIATE A PANIC FUNCTION AT ANY TIME OF DAY OR NIGHT:

Press an active lettered key
for at least two seconds.

or

Press both keys of an active
pair at the same time.

* If connected to central station.

Your system may have been programmed to use special keys or combinations of keys to manually activate emergency (panic) functions. The functions that might be programmed are: Silent Emergency, Audible Emergency, Personal Emergency, and Fire.

A silent emergency sends a silent alarm signal to the central station*, but there is no audible alarm or visual display.

An audible emergency sends a signal to the central station* and sounds a loud, steady alarm at your keypad(s) and at any external sounders that may be connected (ALARM plus a zone number is also displayed).

A personal emergency alarm sends an emergency message to the central station* and sounds at keypad(s), but not at external bells or sirens.

A fire alarm sends a fire alarm message to the central station* and uniquely sounds at keypad(s) and external bells and sirens (FIRE plus a zone number is also displayed).

Also see *Duress Code* feature on page 10.

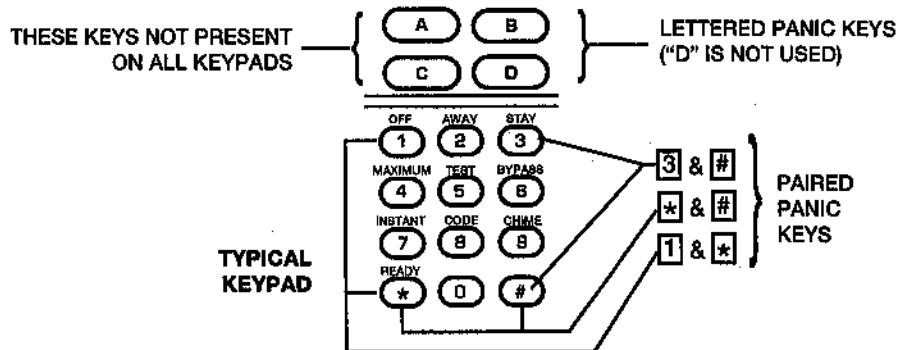

PANIC KEYS

CHECK IF ACTIVE	PANIC KEY(S)	PROGRAMMED FUNCTION	ZONE NUMBER
<input type="checkbox"/>	[A]	___ SILENT, ___ AUDIBLE, ___ PERSONAL, ___ FIRE	95
<input type="checkbox"/>	[B]	___ SILENT, ___ AUDIBLE, ___ PERSONAL, ___ FIRE	07
<input type="checkbox"/>	[C]	___ SILENT, ___ AUDIBLE, ___ PERSONAL, ___ FIRE	96
OR			
<input type="checkbox"/>	[1] & [*]	___ SILENT, ___ AUDIBLE, ___ PERSONAL, ___ FIRE	95
<input type="checkbox"/>	[*] & [#]	___ SILENT, ___ AUDIBLE, ___ PERSONAL, ___ FIRE	07
<input type="checkbox"/>	[3] & [#]	___ SILENT, ___ AUDIBLE, ___ PERSONAL, ___ FIRE	96

SEE YOUR INSTALLER
AND NOTE HERE
THE KEY(S) & FUNCTION(S)
PROGRAMMED
FOR YOUR SYSTEM

- KEYS [A], [B], AND [C] ARE NOT PRESENT ON ALL KEYPADS.
- KEY [D], IF PRESENT ON YOUR KEYPAD, IS NOT ACTIVE HERE.

OUTPUT RELAY OPTIONS

**Programmed
Actions**
(in response to
zone activity
or manual entries)

Ask your installer to provide information on any special system actions that have been programmed during installation.

ACTION	STARTED BY	STOPPED BY

TESTING THE SYSTEM

TO BE CONDUCTED WEEKLY

Using the 5 TEST Key

NO ALARM REPORTS
WILL BE SENT TO THE
CENTRAL MONITORING
STATION while the
system is in Test mode.

The **TEST** key puts your system into Test mode, which allows each protection point to be checked for proper operation.

1. Disarm the system and close all protected windows, doors, etc. The keypad's READY message should be displayed and the READY indicator (if present) should be lit.
2. Enter your security code and press the **TEST** key.
3. As the Test mode is entered, the external siren or bell will sound for one second and then turn off.

Each time a protection zone is faulted during the following steps, the keypad sounds 3 beeps.

The keypad sounds a single beep every 40 seconds as a reminder that the system is in the test mode.

If these sounds do not occur, call for service immediately.

4. Open and close each protected door and window in turn and listen for the required sounds. The identification of each faulted protection point should appear on the display.
5. Walk in front of any interior motion detectors (if used) and listen for the required sound as movement is detected. The identification of the detector should appear on the display when it is activated.

Note: Wireless PIR (Passive Infrared) units will send signals out only if they have been inactive for 3 minutes.

6. Follow the manufacturer's instructions to test all smoke detectors, to ensure that all are functioning properly. The identification of each detector should appear on the display when each is activated.

TESTING THE SYSTEM

7. After all protection points have been checked and restored, there should be no zone identification numbers displayed. **If a problem is experienced with any protection point (no confirming sounds, no display), CALL FOR SERVICE IMMEDIATELY.**
8. Turn off the Test mode by entering the security code and pressing the **OFF** key.

THE TEST MODE WILL BE AUTOMATICALLY TERMINATED AFTER 4 HOURS,
IF THE USER DOES NOT MANUALLY TERMINATE IT SOONER.
This insures that the Fire and Panic zones will not remain disabled.

TROUBLE CONDITIONS

"Check" and "Battery" Displays

The word **CHECK** on the keypad's display, accompanied by a "beeping" at the keypad, indicates a trouble condition in the system.

To silence the beeping for these conditions, press any key.

1. A display of "**CHECK**" and one or more zone numbers indicates that a problem exists with the displayed zone(s) and requires your attention. If the **CHECK** display relates to a fire zone, **CALL FOR SERVICE IMMEDIATELY**.

Determine if the zone(s) displayed are intact and make them so if they are not. If the problem has been corrected, the display can be cleared if you enter the OFF sequence (user code plus OFF key) twice. If the display persists, **CALL FOR SERVICE IMMEDIATELY**.

2. If there are wireless sensors* in your system, the **CHECK** condition may also be caused by some change in the environment that prevents the receiver from hearing a particular sensor. **CALL FOR SERVICE IMMEDIATELY** if this occurs.

* Not all systems use wireless sensors.

IF YOU CANNOT CORRECT
A "CHECK" DISPLAY,
OR IF IT IS FOR A FIRE ZONE,
CALL FOR SERVICE IMMEDIATELY.

TYPICAL "CHECK" DISPLAYS

*CHECK 06 FRONT
UPSTAIRS BEDROOM*

ALPHA

06

AC

CHECK

FIXED-WORD

TROUBLE CONDITIONS

3. A display of "BAT" with no zone number indicates that the main standby battery in your control is weak. If this condition persists for more than one day (with AC present), CALL FOR SERVICE.
4. A display of "BAT" with a zone number and a once per minute "beeping" at the Keypad indicates that a low battery condition exists in the wireless sensor displayed. Either replace the battery yourself, or CALL FOR SERVICE. If the battery is not replaced within 30 days, a CHECK display may occur.

Some wireless sensors contain a non-replaceable long-life battery which requires replacement of the entire unit at the end of battery life (e.g., 5802 Pendant and 5802CP Belt Clip Personal Emergency Transmitters and 5803 Wireless Key Transmitters).

Power Failure If there is no keypad display at all, and the POWER indicator (if present) is not lit, operating power for the system has stopped and the system is inoperative. CALL FOR SERVICE IMMEDIATELY.

If the message "AC LOSS" or "NO AC" is displayed, and the POWER indicator (if present) is off, the Keypad is operating on battery power only. If only some lights are out on the premises, check circuit breakers and fuses and reset or replace as necessary. CALL FOR SERVICE IMMEDIATELY if AC power cannot be restored.

TROUBLE CONDITIONS

Other Displays
Fixed-Word
Keypads

- dl:** If this remains displayed for more than 1 minute, your system is disabled.
CALL FOR SERVICE IMMEDIATELY.
- CC:** The system is in communication with the central station for change of function or status verification. **If this message persists for more than 10 minutes, CALL FOR SERVICE IMMEDIATELY.**
- FC:** A communication failure with the central station has occurred.
CALL FOR SERVICE IMMEDIATELY.
- OC:** The keypad is not receiving signals from the control panel and sees an open circuit. *If this message persists for more than 10 minutes, CALL FOR SERVICE IMMEDIATELY.*

**FOR SERVICING
INFORMATION,
SEE PAGE 43**

FIRE ALARM SYSTEM IF INSTALLED

General Your fire alarm system (if installed) is on 24 hours a day, for continuous protection. In the event of an emergency, the strategically located smoke and heat detectors will automatically send signals to your system, triggering a loud, interrupted sound from the Keypad. An interrupted sound will also be produced by optional exterior sounders. A FIRE message will appear at your Keypad and remain on until you silence the alarm.

In Case Of Fire Alarm

1. Should you become aware of a fire emergency before your detectors sense the problem, go to your nearest Keypad and manually initiate an alarm by pressing the panic key pair assigned as FIRE emergency (if programmed by the installer) as indicated on page 23.
2. Evacuate all occupants from the premises.
3. If flames and/or smoke are present, leave the premises and notify your local Fire Department immediately.
4. If no flames or smoke are apparent, investigate the cause of the alarm. The zone number(s) of the zone(s) in an alarm condition will be displayed at the Keypad.

TYPICAL FIRE EMERGENCY DISPLAYS



ALPHA



FIXED-WORD

FIRE ALARM SYSTEM

IF INSTALLED

Silencing Fire Alarms

1. Silence the alarm by pressing the **OFF** key (security code not needed to silence fire alarms). To clear the display, enter your code and press the **OFF** key again (Memory of Alarm).
2. If the Keypad's fire indication does not clear after the second **OFF** sequence, smoke detectors may still be responding to smoke or heat producing objects in their vicinity. Investigate, and should this be the case, eliminate the source of heat or smoke.
3. If this does not remedy the problem, there may still be smoke in the detector. Clear it by fanning the detector for about 30 seconds.
4. When the problem has been corrected, clear the display by entering your code and pressing the **OFF** key.

NATIONAL FIRE PROTECTION ASSOCIATION RECOMMENDATIONS ON SMOKE DETECTORS

General With regard to the number and placement of smoke/heat detectors, we subscribe to the recommendations contained in the National Fire Protection Association's Standard #74 noted below.

Early warning fire detection is best achieved by the installation of fire detection equipment in all rooms and areas of the household as follows: A smoke detector installed outside of each separate sleeping area, in the immediate vicinity of the bedrooms and on each additional story of the family living unit, including basements and excluding crawl spaces and unfinished attics.

In addition, it is recommended that the householder consider the use of heat or smoke detectors in the living room, dining room, bedroom(s), kitchen, hallway(s), attic, furnace room, utility and storage rooms, basements and attached garages.

BEST RESIDENTIAL
DETECTOR PLACEMENT
BETWEEN BEDROOMS
AND REST OF HOUSE

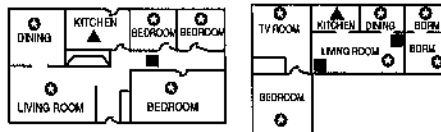

PLACE DETECTOR
NEAR ALL SLEEPING
AREAS

MAXIMUM FLOOR
COVERAGE -
DETECTORS AT
TOP OF STAIRWELLS

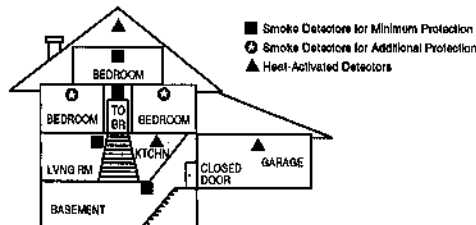

EMERGENCY EVACUATION

Steps to Safety

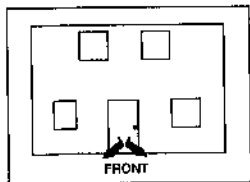
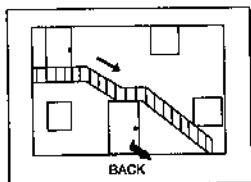
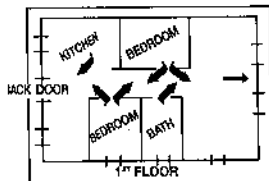
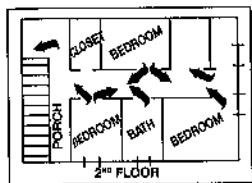

Establish and regularly practice a plan of escape in the event of fire. The following steps are recommended by the National Fire Protection Association:

1. Plan on your detector or your interior and/or exterior sounders warning all occupants.
2. Determine two means of escape from each room. One path of escape should lead to the door that permits normal exit from the building. The other may be a window, should your path be unpassable. Station an escape ladder at such windows if there is a long drop to the ground.
3. Sketch a floor plan of the building. Show windows, doors, stairs and rooftops that can be used to escape. Indicate escape routes for each room. Keep these routes free from obstruction and post copies of the escape routes in every room.
4. Assure that all bedroom doors are shut while you are asleep. This will prevent deadly smoke from entering while you escape.
5. Try the door. If the door is hot, check your alternate escape route. If the door is cool, open it cautiously. Be prepared to slam the door if smoke or heat rushes in.
6. In smoky areas, crawl close to floor, hold your breath, and/or cover mouth and nose with a wet cloth.
7. Escape quickly; don't panic.
8. Establish a common meeting place outdoors, away from your premises, where everyone can meet and then take steps to contact the authorities and account for those missing. Choose someone to assure that nobody returns to the premises — many die going back.

QUICK GUIDE TO ALARM SYSTEM FUNCTIONS

FUNCTION	PROCEDURE	COMMENTS
Check Zones	Press READY key.	To view faulted zones when system not ready.
Arm System	Enter code. Press arming key desired: (AWAY, STAY, INSTANT, MAXIMUM)	Arms system in mode selected.
Quick Arm (if programmed)	Press #. Press arming key desired: (AWAY, STAY, INSTANT, MAXIMUM)	Arms system in mode selected, quickly and without use of code.
Bypass Zone(s)	Enter code. Press BYPASS key. Enter zone number(s) to be bypassed (use 2-digit entries).	Bypassed zones are unprotected and will not cause an alarm if violated.
Quick Bypass (if programmed)	Enter code. Press BYPASS key.	Bypasses all faulted zones automatically, plus (if so-programmed), zones 17, 30, 31, 46, 47 if they are in system.
Silence Sounders		
Burglary:	Enter code. Press OFF key.	Also disarms system. Memory of alarm remains until cleared.
Fire:	Press OFF key.	Memory of Alarm remains until cleared.
"Check":	Press any key.	Determine cause. See Page 26.
Disarm System	Enter code. Press OFF key.	Also silences sounders. Memory of alarm remains until cleared.
Clear Alarm Memory	After disarming, enter code again. Press OFF key again.	Keypad will beep rapidly upon entry if alarm has occurred. Alarm display will remain upon disarming until cleared.
Duress (if active and connected to central station)	Arm or disarm "normally", but with 4th digit of code increased by "1".	Performs desired action and sends silent alarm to central station.
Panic Alarms (as programmed)	Press key [A], [B], or [C] for at least 2 sec., or (if no A, B, or C on your keypad) press keys [1]&[*], or [*]&[#], or [3]&[#], both at same time.	See Page 22 for functions programmed for your system.
Chime Mode	To turn ON or OFF: Enter code. Press CHIME key.	Keypad will sound if doors or windows are violated while system is disarmed and chime mode is ON.
Test Mode	To turn ON: Enter code. Press TEST key. To turn OFF: Enter code. Press OFF key.	Tests alarm sounder and allows sensors to be tested.
Phone Access (Voice Module) if applicable	Consult <i>Phone Access User's Guide</i> that accompanies Voice Module.	Permits system access remotely, via Touch-tone phone (see pages 4, 11).

SUMMARY OF AUDIBLE/VISUAL NOTIFICATION (ALPHA DISPLAY KEYPADS)

SOUND	CAUSE	DISPLAY
LOUD, INTERRUPTED* Keypad & External	FIRE ALARM	FIRE is displayed; descriptor of zone in alarm is displayed.
LOUD, CONTINUOUS* Keypad & External	BURGLARY/AUDIBLE EMERGENCY ALARM	ALARM is displayed; descriptor of zone in alarm is also displayed.. Also see "Exit Alarm Warning Displays and Sounds" on page 21.
ONE SHORT BEEP (not repeated) Keypad only	a. SYSTEM DISARM b. SYSTEM ARMING ATTEMPT WITH AN OPEN ZONE c. BYPASS VERIFY	a. DISARMED/READY TO ARM is displayed. Green READY indicator (if present) is lit. b. The number and descriptor of the open protection zone is displayed. Green READY indicator (if present) is not lit. c. Numbers and descriptors of the bypassed protection zones are displayed (One beep is heard for each zone displayed). Subsequently, the following is displayed: DISARMED BYPASS Ready to Arm
ONE SHORT BEEP every 60 sec. Keypad only	SYSTEM IS IN TEST MODE	Opened Zone identifications will appear.
ONE BEEP every 60 sec. Keypad only	a. LOW BATTERY AT A XMTR b. SYSTEM MAIN BATT. WEAK c. TROUBLE	a. LO BAT displayed with description of transmitter. b. LO BAT displayed with no transmitter description. c. CHECK displayed. Descriptor of troubled protection zone is displayed.
TWO SHORT BEEPS Keypad only	ARM AWAY OR MAXIMUM	ARMED AWAY or ARMED MAXIMUM is displayed. Red ARMED indicator is lit.
THREE SHORT BEEPS Keypad only	a. ARM STAY OR INSTANT b. ZONE OPENED WHILE SYS- TEM IS IN CHIME MODE c. ZONE OPENED WHILE SYS- TEM IS IN TEST MODE	a. ARMED STAY or ARMED INSTANT is displayed. Red ARMED indicator is lit. b. CHIME displayed. Pressing */ READY key will display descriptor of opened zone. c. Open protection zone descriptor is displayed.
RAPID BEEPING Keypad only	MEMORY OF ALARM	FIRE or ALARM is displayed; descriptor of zone in alarm is displayed.
SLOW BEEPING Keypad only	a. ENTRY DELAY WARNING b. EXIT DELAY ALERT (if programmed)	a. DISARM SYSTEM OR ALARM WILL OCCUR is displayed. Exceeding the delay time without disarming causes alarm. b. ARMED AWAY or ARMED MAXIMUM is displayed. Slow beeps change to fast during last 5 sec of exit delay.

*If bell is used as external sounder, fire alarm is pulsed ring; burglary/audible emergency is steady ring.

Note: Also see *Power Failure* under **TROUBLE CONDITIONS** on page 27.

SUMMARY OF AUDIBLE/VISUAL NOTIFICATION (FIXED-WORD DISPLAY KEYPADS)

SOUND	CAUSE	DISPLAY
LOUD, INTERRUPTED* Keypad & External	FIRE ALARM	FIRE and ALARM are displayed; protection zone in alarm is displayed.
LOUD, CONTINUOUS* Keypad & External	BURGLARY/AUDIBLE EMERGENCY ALARM	ALARM is displayed; protection zone in alarm is also displayed. Also see "Exit Alarm Warning Displays and Sounds" on page 21.
ONE SHORT BEEP (not repeated) Keypad only	a. SYSTEM DISARM b. SYSTEM ARMING ATTEMPT WITH AN OPEN ZONE c. BYPASS VERIFY	a. Only READY is displayed. Green READY indicator (if present) is lit. b. NOT READY is displayed, open protection zone number is displayed. Green READY indicator (if present) is not lit. c. The bypassed protection zone numbers are displayed. (One beep for each number displayed.) BYPASS displayed.
ONE SHORT BEEP (once every 60 seconds) Keypad only	SYSTEM IS IN TEST MODE	Opened Zone identifications will appear.
ONE BEEP every 60 sec. Keypad only	a. LOW BATTERY AT XMTR b. SYST. MAIN BATT. WEAK c. TROUBLE	a. BAT displayed with ID number of transmitter. b. BAT displayed with no transmitter ID c. CHECK displayed. Troubled protection zone is displayed.
TWO SHORT BEEPS Keypad only	ARM AWAY OR MAXIMUM	AWAY and (if MAXIMUM) INSTANT are displayed.
THREE SHORT BEEPS Keypad only	a. ARM STAY OR INSTANT b. ZONE OPENED WHILE SYS- TEM IS IN CHIME MODE c. ZONE OPENED WHILE SYS- TEM IS IN TEST MODE	a. STAY and (if INSTANT) INSTANT are displayed. Red ARMED indicator is lit. b. CHIME displayed. Pressing */ READY key will display opened zone. c. Open protection zone number is displayed.
RAPID BEEPING Keypad only	MEMORY OF ALARM	FIRE and/or ALARM is displayed; zone in alarm is displayed.
SLOW BEEPING Keypad only	a. ENTRY DELAY WARNING b. EXIT DELAY ALERT (if programmed)	a. No display during delay; Exceeding the delay time without disarming causes alarm. b. AWAY or (if MAXIMUM) AWAY INSTANT is displayed. Slow beeps change to fast during last 5 sec of exit delay.

*If bell is used as external sounder, fire alarm is pulsed ring; burglary/audible emergency is steady ring.

Note: Also see *Power Failure*, and *Other Displays* under *TROUBLE CONDITIONS* on page 27.

PROTECTION ZONES LIST

One or more sensing devices will have been assigned by the installer of your alarm system to each of the various protection zones in your system (*although not every zone number can be used*). For example, the sensing device on your Entry/Exit door may have been assigned to zone 06, sensing devices on windows in the master bedroom to zone 10, and so on.

Zone numbers 07, 95 and 96 represent Keypad "Panic" alarm functions assigned by the installer (see Page 22). Zone numbers 08 and 09 are reserved for Duress and Tamper signal reporting to the central station.

This chart may be used to record the specific zone number assignments for your system. Your installer will assist you in recording this information.

PROTECTION ZONE DESCRIPTIONS

Zone	Description	Zone	Description	Zone	Description	Zone	Description
01		17		34		51	
02		18		35		52	
03		19		36		53	
04		20		37		54	
05		21		38		55	
06		22		39		56	
07	Key B (or: * & #) Panic	23		40		57	
		24		41		58	
08	-Duress-	25		42		59	
09	-Tamper-	26		43		60	
10		27		44		61	
11		28		45		62	
12		29		46		63	
13		30		47		95	Key A (or: 1 & *) Panic
14		31		48			
15		32		49		96	Key C (or: 3 & #) Panic
16		33		50			



OWNER'S INSURANCE PREMIUM CREDIT REQUEST

This form should be completed and forwarded to your homeowner's insurance carrier for possible premium credit.

A. GENERAL INFORMATION:

Insured's Name and Address: _____

Insurance Company: _____ Policy No.: _____

First Alert Professional FA140C System

Type of Alarm: Burglary Fire Both

Installed by: _____ name _____ Served by: _____ name _____
address address

B. NOTIFIED (Insert B for Burglary, F for Fire, where appropriate):

Local Sounding Device _____ Police Dept. _____ Fire Dept. _____ Central Station _____

Name and Address: _____

C. POWERED BY: A.C. With Rechargeable Power Supply

D. TESTING: Quarterly, Monthly, Weekly, Other _____

continued on other side

OWNER'S INSURANCE PREMIUM CREDIT REQUEST (cont.)

E. SMOKE DETECTOR LOCATIONS:

- | | | | |
|---------------------------------------|--------------------------------------|--------------------------------------|--------------------------------|
| <input type="checkbox"/> Furnace Room | <input type="checkbox"/> Kitchen | <input type="checkbox"/> Bedrooms | <input type="checkbox"/> Attic |
| <input type="checkbox"/> Basement | <input type="checkbox"/> Living Room | <input type="checkbox"/> Dining Room | <input type="checkbox"/> Hall |

F. BURGLARY DETECTING DEVICE LOCATIONS:

- | | | | |
|---|--|---|---|
| <input type="checkbox"/> Front Door | <input type="checkbox"/> Basement Door | <input type="checkbox"/> Rear Door | <input type="checkbox"/> All Exterior Doors |
| <input type="checkbox"/> 1st Floor Windows | <input type="checkbox"/> All windows | <input type="checkbox"/> Interior Locations | |
| <input type="checkbox"/> All Accessible Openings, Including Skylights, Air Conditioners and Vents | | | |

G. ADDITIONAL PERTINENT INFORMATION:

Signature: _____ Date: _____

CANADIAN DEPARTMENT OF COMMUNICATIONS (DOC) STATEMENT

NOTICE

The Canadian Department of Communications label identifies certified equipment. This certification means that the equipment meets certain telecommunications network protective, operational and safety requirements. The Department does not guarantee the equipment will operate to the user's satisfaction.

Before installing this equipment, users should ensure that it is permissible to be connected to the facilities of the local telecommunications company. The equipment must also be installed using an acceptable method of connection. In some cases, the company's inside wiring associated with a single line individual service may be extended by means of certified connector assembly (telephone extension cord). The customer should be aware that compliance with the above conditions may not prevent degradation of service in some situations.

Repairs to certified equipment should be made by an authorized Canadian maintenance facility designated by the supplier. Any repairs or alterations made by the user to this equipment, or equipment malfunctions, may give the telecommunications company cause to request the user to disconnect the equipment.

Users should ensure for their own protection that the electrical ground connections of the power utility, telephone lines and internal metallic water pipe system, if present, are connected together. This precaution may be particularly important in rural areas.

Caution: User should not attempt to make such connections themselves, but should contact the appropriate electric inspection authority, or electrician, as appropriate.

The Load Number (LN) assigned to each terminal device denotes the percentage of the total load to be connected to a telephone loop which is used by the device, to prevent overloading. The termination on a loop may consist of any combination of devices subject only to the requirement that the total of the Load Numbers of all the devices does not exceed 100.

AVIS

L'étiquette du ministère des Communications du Canada identifie le matériel homologué. Cette étiquette certifie que le matériel est conforme à certaines normes de protection, d'exploitation et de sécurité des réseaux de télécommunications. Le ministère n'assure toutefois pas que le matériel fonctionnera à la satisfaction de l'utilisateur.

Avant d'installer ce matériel, l'utilisateur doit s'assurer qu'il est permis de le raccorder aux installations de l'entreprise locale de télécommunications. Le matériel doit également être installé en suivant une méthode acceptée de raccordement. Dans certains cas, les fils intérieurs de l'entreprise utilisés pour un service individuel à la ligne unique peuvent être prolongés au moyen d'un dispositif homologué de raccordement (cordon prolongateur téléphonique interne). L'abonné ne doit pas oublier qu'il est possible que la conformité aux conditions énoncées ci-dessus n'empêche pas la dégradation du service dans certaines situations. Actuellement, les entreprises de télécommunications ne permettent pas que l'on raccorde leur matériel aux prises d'abonnés, sauf dans les cas précis prévus par les tarifs particuliers de ces entreprises.

Les réparations du matériel homologué doivent être effectuées pas un centre d'entretien canadien autorisé désigné par le fournisseur. La compagnie de télécommunications peut demander à l'utilisateur de débrancher un appareil à la suite de réparations ou de modifications effectuées par l'utilisateur ou à cause de mauvais fonctionnement.

Pour sa propre protection, l'utilisateur doit s'assurer que tous les fils de mise en terre de la source d'énergie électrique, des lignes téléphoniques de réseau de conduites d'eau, s'il y en a, soient raccordés ensemble. Cette précaution est particulièrement importante dans les régions rurales.

Avertissement: L'utilisateur ne doit pas tenter de faire ces raccordements lui-même; il doit avoir recours à un service d'inspection des installations électriques, ou à un électricien, selon le cas.

L'indice de charge (IC) assigné à chaque dispositif terminal pour éviter toute surcharge indique le pourcentage de la charge totale qui peut être raccordé à un circuit téléphonique fermé utilisé par ce dispositif. La terminaison du circuit fermé peut être constituée de n'importe quelle combinaison de dispositifs, pourvu que la somme des indices de charge de l'ensemble des dispositifs ne dépasse pas 100.

UL NOTICE: This is a "Grade A" Residential System.

FEDERAL COMMUNICATIONS COMMISSION (FCC) Part 15 STATEMENT

This equipment has been tested to FCC requirements and has been found acceptable for use. The FCC requires the following statement for your information:

This equipment generates and uses radio frequency energy and if not installed and used properly, that is, in strict accordance with the manufacturer's instructions, may cause interference to radio and television reception. It has been type tested and found to comply with the limits for a Class B computing device in accordance with the specifications in Part 15 of FCC Rules, which are designed to provide reasonable protection against such interference in a residential installation. However, there is no guarantee that interference will not occur in a particular installation. If this equipment does cause interference to radio or television reception, which can be determined by turning the equipment off and on, the user is encouraged to try to correct the interference by one or more of the following measures:

- If using an indoor antenna, have a quality outdoor antenna installed.
- Reorient the receiving antenna until interference is reduced or eliminated.
- Move the radio or television receiver away from the receiver/control.
- Move the antenna leads away from any wire runs to the receiver/control.
- Plug the receiver/control into a different outlet so that it and the radio or television receiver are on different branch circuits.

If necessary, the user should consult the dealer or an experienced radio/television technician for additional suggestions. The user or installer may find the following booklet prepared by the Federal Communications Commission helpful:

"Interference Handbook"

This booklet is available from the U.S. Government Printing Office, Washington, DC 20402.

The user shall not make any changes or modifications to the equipment unless authorized by the Installation Instructions or User's Manual. Unauthorized changes or modifications could void the user's authority to operate the equipment.

IN THE EVENT OF TELEPHONE OPERATIONAL PROBLEMS

In the event of telephone operational problems, disconnect the control by removing the plug from the RJ31X wall jack. We recommend that your certified installer demonstrate disconnecting the phones on installation of the system. Do not disconnect the phone connection inside the control/communicator. Doing so will result in the loss of your phone lines. If the regular phone works correctly after the control/communicator has been disconnected from the phone lines, the control/communicator has a problem and should be returned for repair. If upon disconnection of the control/communicator, there is still a problem on the line, notify the telephone company that they have a problem and request prompt repair service. The user may not under any circumstances (in or out of warranty) attempt any service or repairs to the system. It must be returned to the factory or an authorized service agency for all repairs.

FEDERAL COMMUNICATIONS COMMISSION (FCC) Part 68 STATEMENT

This equipment complies with Part 68 of the FCC rules. On the front cover of this equipment is a label that contains, among other information, the FCC registration number and ringer equivalence number (REN) for this equipment. If requested, this information must be provided to the telephone company.

This equipment uses the following jacks: An RJ31X is used to connect this equipment to the telephone network.

The REN is used to determine the quantity of devices which may be connected to the telephone line. Excessive RENs on the telephone line may result in the devices not ringing in response to an incoming call. In most, but not all areas, the sum of the RENs should not exceed five (5.0). To be certain of the number of devices that may be connected to the line, as determined by the total RENs, contact the telephone company to determine the maximum REN for the calling area.

If this equipment causes harm to the telephone network, the telephone company will notify you in advance that temporary discontinuance of service may be required. If advance notice is not practical, the telephone company will notify the customer as soon as possible. Also, you will be advised of your right to file a complaint with the FCC if you believe necessary.

The telephone company may make changes in its facilities, equipment, operations, or procedures that could affect the operation of the equipment. If this happens, the telephone company will provide advance notice in order for you to make the necessary modifications in order to maintain uninterrupted service.

If trouble is experienced with this equipment, please contact the manufacturer for repair and warranty information. If the trouble is causing harm to the telephone network, the telephone company may request you remove the equipment from the network until the problem is resolved.

There are no user serviceable components in this product, and all necessary repairs must be made by the manufacturer. Other repair methods may invalidate the FCC registration on this product.

This equipment cannot be used on telephone company-provided coin service. Connection to Party Line Service is subject to state tariffs.

This equipment is hearing-aid compatible.

When programming or making test calls to an emergency number, briefly explain to the dispatcher the reason for the call. Perform such activities in the off-peak hours; such as early morning or late evening.

WARNING!

THE LIMITATIONS OF THIS ALARM SYSTEM

While this system is an advanced design security system, it does not offer guaranteed protection against burglary or fire or other emergency. Any alarm system, whether commercial or residential, is subject to compromise or failure to warn for a variety of reasons. For example:

- Intruders may gain access through unprotected openings or have the technical sophistication to bypass an alarm sensor or disconnect an alarm warning device.
- Intrusion detectors (e.g. passive infrared detectors), smoke detectors, and many other sensing devices will not work without power. Battery operated devices will not work without batteries, with dead batteries, or if the batteries are not put in properly. Devices powered solely by AC will not work if their AC power supply is cut off for any reason, however briefly.
- Signals sent by wireless transmitters may be blocked or reflected by metal before they reach the alarm receiver. Even if the signal path has been recently checked during a weekly test, blockage can occur if a metal object is moved into the path.
- A user may not be able to reach a panic or emergency button quickly enough.
- While smoke detectors have played a key role in reducing residential fire deaths in the United States, they may not activate or provide early warning for a variety of reasons in as many as 35% of all fires, according to data published by the Federal Emergency Management Agency. Some of the reasons smoke detectors used in conjunction with this System may not work are as follows. Smoke detectors may have been improperly installed and positioned. Smoke detectors may not sense fires that start where smoke cannot reach the detectors, such as in chimneys, in walls, or roofs, or on the other side of closed doors. Smoke detectors also may not sense a fire on another level of a residence or building. A second floor detector, for example, may not sense a first floor or basement fire. Moreover, smoke detectors have sensing limitations. No smoke detector can sense every kind of fire every time. In general, detectors may not always warn about fires caused by carelessness and safety hazards like smoking in bed, violent explosions, escaping gas, improper storage of flammable materials, overloaded electrical circuits, children playing with matches, or arson. Depending upon the nature of the fire and/or the locations of the smoke detectors, the detector, even if it operates as anticipated, may not provide sufficient warning to allow all occupants to escape in time to prevent injury or death.
- Passive Infrared Motion Detectors can only detect intrusion within the designed ranges as diagrammed in their installation manual. Passive Infrared Detectors do not provide volumetric area protection. They do create multiple beams of protection, and intrusion can only be detected in unobstructed areas covered by those beams. They cannot detect motion or intrusion that takes place behind walls, ceilings, floors, closed doors, glass partitions, glass doors, or windows. Mechanical tampering, masking, painting or spraying of any material on the mirrors, windows or any part of the optical system can reduce their detection ability. Passive Infrared Detectors sense changes in temperature; however, as the ambient temperature of protected area approaches the temperature range of 90° to 105°F (32° to 40°C), the detection performance can decrease.

(continued)

(continued) WARNING! THE LIMITATIONS OF THIS ALARM SYSTEM

- Alarm warning devices such as sirens, bells or horns may not alert people or wake up sleepers if they are located on the other side of closed or partly open doors. If warning devices sound on a different level of the residence from the bedrooms, then they are less likely to waken or alert people inside the bedrooms. Even persons who are awake may not hear the warning if the alarm is muffled from a stereo, radio, air conditioner or other appliance, or by passing traffic. Finally, alarm warning devices, however loud, may not warn hearing-impaired people or waken deep sleepers.
- Telephone lines needed to transmit alarm signals from a premises to a central monitoring station may be out of service or temporarily out of service. Telephone lines are also subject to compromise by sophisticated intruders.
- Even if the system responds to the emergency as intended, however, occupants may have insufficient time to protect themselves from the situation. In the case of a monitored alarm system, authorities may not respond appropriately.
- This equipment, like other electrical devices, is subject to component failure. Even though this equipment is designed to last as long as 10 years, the electronic components could fail at any time.

The most common cause of an alarm system not functioning when an intrusion or fire occurs is inadequate maintenance. This alarm system should be tested weekly to make sure all sensors and transmitters are working properly.

Wireless transmitters (used with some systems) are designed to provide long battery life under normal operating conditions. Longevity of batteries may be as much as 4 to 7 years, depending on the environment, usage, and the specific wireless device being used. External factors such as humidity, high or low temperatures, as well as large swings in temperature, may all reduce the actual battery life in a given installation. This wireless system, however, can identify a true low battery situation, thus allowing time to arrange a change of battery to maintain protection for that given point within the system.

Installing an alarm system may make one eligible for lower insurance rates, but an alarm system is not a substitute for insurance. Homeowners, property owners and renters should continue to act prudently in protecting themselves and continue to insure their lives and property.

We continue to develop new and improved protection devices. Users of alarm systems owe it to themselves and their loved ones to learn about these developments.

SERVICING INFORMATION

Your local authorized service representative is the person best qualified to service your alarm system. Arranging a regular program with that person is advisable. Your local service representative is:

NAME: _____ PHONE: _____

ADDRESS: _____

ONE YEAR LIMITED WARRANTY

Pittway Corporation, and its divisions, subsidiaries and affiliates ("Seller"), 165 Eileen Way, Syosset, New York 11791, warrants its First Alert Professional security equipment (the "product") to be free from defects in materials and workmanship for one year from date of original purchase, under normal use and service. Seller's obligation is limited to repairing or replacing, at its option, free of charge for parts, labor, or transportation, any product proven to be defective in materials or workmanship under normal use and service. Seller shall have no obligation under this warranty or otherwise if the product is altered or improperly repaired or serviced by anyone other than the Seller. In case of defect, contact the security professional who installed and maintains your security equipment or the Seller for product repair.

This one year Limited Warranty is in lieu of all other express warranties, obligations or liabilities. THERE ARE NO EXPRESS WARRANTIES, WHICH EXTEND BEYOND THE FACE HEREOF. ANY IMPLIED WARRANTIES, OBLIGATIONS OR LIABILITIES MADE BY SELLER IN CONNECTION WITH THIS PRODUCT, INCLUDING ANY IMPLIED WARRANTY OF MERCHANTABILITY, OR FITNESS FOR A PARTICULAR PURPOSE OR OTHERWISE, ARE LIMITED IN DURATION TO A PERIOD OF ONE YEAR FROM THE DATE OF ORIGINAL PURCHASE. ANY ACTION FOR BREACH OF ANY WARRANTY, INCLUDING BUT NOT LIMITED TO ANY IMPLIED WARRANTY OF MERCHANTABILITY, MUST BE BROUGHT WITHIN 12 MONTHS FROM DATE OF ORIGINAL PURCHASE. IN NO CASE SHALL SELLER BE LIABLE TO ANYONE FOR ANY CONSEQUENTIAL OR INCIDENTAL DAMAGES FOR BREACH OF THIS OR ANY OTHER WARRANTY, EXPRESS OR IMPLIED, OR UPON ANY OTHER BASIS OF LIABILITY WHATSOEVER, EVEN IF THE LOSS OR DAMAGE IS CAUSED BY THE SELLER'S OWN NEGLIGENCE OR FAULT. Some states do not allow limitation on how long an implied warranty lasts or the exclusion or limitation of incidental or consequential damages, so the above limitation or exclusion may not apply to you.

Seller does not represent that the product may not be compromised or circumvented; that the product will prevent any personal injury or property loss by burglary, robbery, fire or otherwise; or that the product will in all cases provide adequate warning or protection. Buyer understands that a properly installed and maintained alarm may only reduce the risk of a burglary, robbery, fire or other events occurring without providing an alarm, but it is not insurance or a guarantee that such will not occur or that there will be no personal injury or property loss as a result. CONSEQUENTLY, SELLER SHALL HAVE NO LIABILITY FOR ANY PERSONAL INJURY, PROPERTY DAMAGE OR OTHER LOSS BASED ON A CLAIM THE PRODUCT FAILED TO GIVE WARNING. HOWEVER, IF SELLER IS HELD LIABLE, WHETHER DIRECTLY OR INDIRECTLY, FOR ANY LOSS OR DAMAGE ARISING UNDER THIS LIMITED WARRANTY OR OTHERWISE, REGARDLESS OF CAUSE OR ORIGIN, SELLER'S MAXIMUM LIABILITY SHALL NOT IN ANY CASE EXCEED THE PURCHASE PRICE OF THE PRODUCT, WHICH SHALL BE THE COMPLETE AND EXCLUSIVE REMEDY AGAINST SELLER. This warranty gives you specific legal rights, and you may also have other rights which vary from state to state. No increase or alteration, written or verbal, to this warranty is authorized.

